

RIVA\CLADDING

Format: Narrow slat

Species: White oak

Color: Crystal



Product description

Add depth and personality to interior spaces with this decorative covering that will turn any room into a distinctive area. Usually found in living rooms or interior walls, its benefits include insulation and noise reduction. A work of art on its own!

Dimensions

Total thickness 7/8" (22mm)

Width 3 3/4" (96mm)

Length (ft) 10' (118")

Dimensional tolerances (EN 13647)

Length: Nominal $\pm 0.1\%$

Width: Nominal $\pm 0.2\%$

Cupping: 0.2% of nominal width

Banana: 0.1% nominal length

Construction

Solid

Finish

Water based varnish

Dimensional stability (EN-1910):

Movement $\leq 0.29\%$

Formaldehyde emission (EN-120)

E0. CARB2 comply

Noise & impact isolation (UNE-EN-ISO 140-8)

ΔL_w : 17 dB

Fire reaction (UNE 23727)

Cfl-S1

Profiling system

Tongue & groove, beveled 2 sides

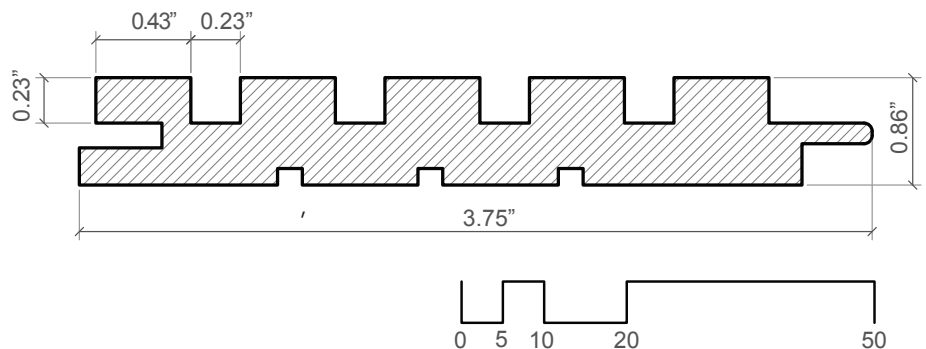

RIVA\CLADDING

Format: Narrow slat

Species: White oak

Color: Pearl



Product description

Add depth and personality to interior spaces with this decorative covering that will turn any room into a distinctive area. Usually found in living rooms or interior walls, its benefits include insulation and noise reduction. A work of art on its own!

Dimensions

Total thickness 7/8" (22mm)

Width 3 3/4" (96mm)

Length (ft) 10' (118")

Dimensional tolerances (EN 13647)

Length: Nominal $\pm 0.1\%$

Width: Nominal $\pm 0.2\%$

Cupping: 0.2% of nominal width

Banana: 0.1% nominal length

Construction

Solid

Finish

Water based varnish

Dimensional stability (EN-1910):

Movement $\leq 0.29\%$

Formaldehyde emission (EN-120)

E0. CARB2 comply

Noise & impact isolation (UNE-EN-ISO 140-8)

ΔL_w : 17 dB

Fire reaction (UNE 23727)

Cfl-S1

Profiling system

Tongue & groove, beveled 2 sides

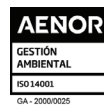
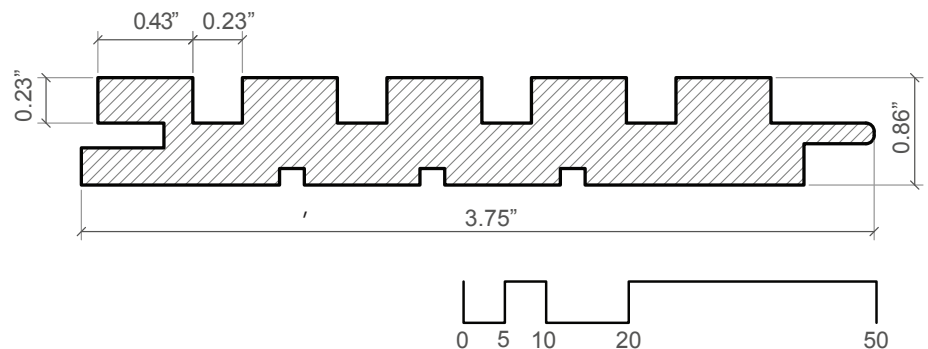

RIVA\CLADDING

Format: Narrow slat

Species: Walnut

Color: Walnut



Product description

Add depth and personality to interior spaces with this decorative covering that will turn any room into a distinctive area. Usually found in living rooms or interior walls, its benefits include insulation and noise reduction. A work of art on its own!

Dimensions

Total thickness 7/8" (22mm)

Width 3 3/4" (96mm)

Length (ft) 10' (118")

Dimensional tolerances (EN 13647)

Length: Nominal $\pm 0.1\%$

Width: Nominal $\pm 0.2\%$

Cupping: 0.2% of nominal width

Banana: 0.1% nominal length

Construction

Solid

Finish

Water based varnish

Dimensional stability (EN-1910):

Movement $\leq 0.29\%$

Formaldehyde emission (EN-120)

E0. CARB2 comply

Noise & impact isolation (UNE-EN-ISO 140-8)

ΔL_w : 17 dB

Fire reaction (UNE 23727)

Cfl-S1

Profiling system

Tongue & groove, beveled 2 sides

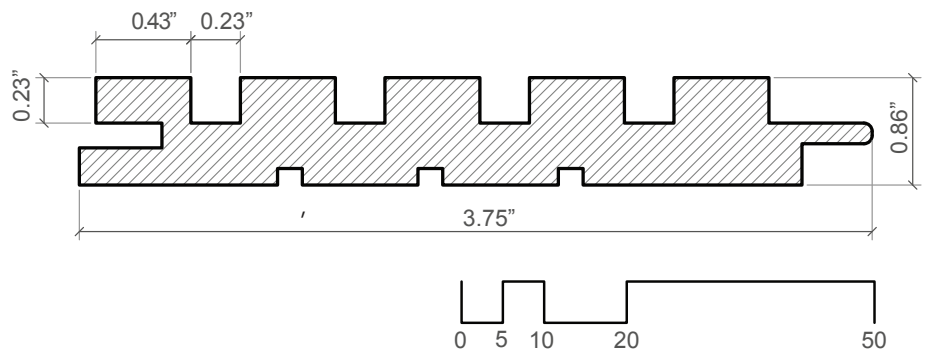

RIVA\CLADDING

Format: Wide slat

Species: White oak

Color: Crystal



Product description

Add depth and personality to interior spaces with this decorative covering that will turn any room into a distinctive area. Usually found in living rooms or interior walls, its benefits include insulation and noise reduction. A work of art on its own!

Dimensions

Total thickness 7/8" (22mm)

Width 3 3/4" (96mm)

Length (ft) 10' (118")

Dimensional tolerances (EN 13647)

Length: Nominal $\pm 0.1\%$

Width: Nominal $\pm 0.2\%$

Cupping: 0.2% of nominal width

Banana: 0.1% nominal length

Construction

Solid

Finish

Water based varnish

Dimensional stability (EN-1910)

Movement $\leq 0.29\%$

Formaldehyde emission (EN-120)

E0. CARB2 comply

Noise & impact isolation (UNE-EN-ISO 140-8)

ΔL_w : 17 dB

Fire reaction (UNE 23727)

Cfl-S1

Profiling system

Tongue & groove, beveled 2 sides

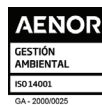
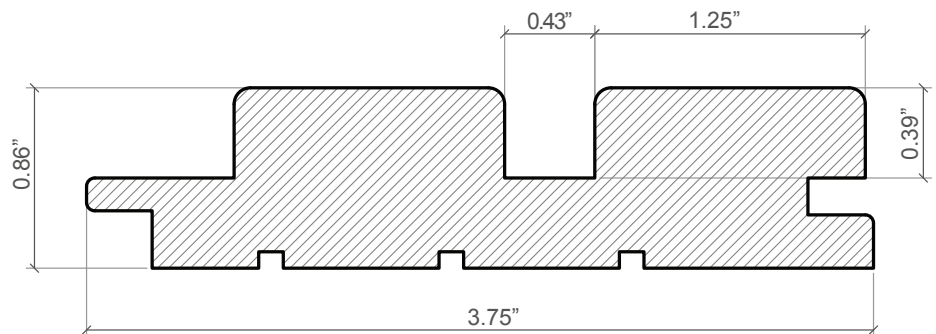

RIVA\CLADDING

Format: Wide slat
Species: White oak
Color: Pearl



Product description

Add depth and personality to interior spaces with this decorative covering that will turn any room into a distinctive area. Usually found in living rooms or interior walls, its benefits include insulation and noise reduction. A work of art on its own!

Dimensions

Total thickness 7/8" (22mm)

Width 3 3/4" (96mm)

Length (ft) 10' (118")

Dimensional tolerances (EN 13647)

Length: Nominal $\pm 0.1\%$

Width: Nominal $\pm 0.2\%$

Cupping: 0.2% of nominal width

Banana: 0.1% nominal length

Construction

Solid

Finish

Water based varnish

Dimensional stability (EN-1910)

Movement $\leq 0.29\%$

Formaldehyde emission (EN-120)

E0. CARB2 comply

Noise & impact isolation (UNE-EN-ISO 140-8)

ΔL_w : 17 dB

Fire reaction (UNE 23727)

Cfl-S1

Profiling system

Tongue & groove, beveled 2 sides

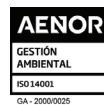
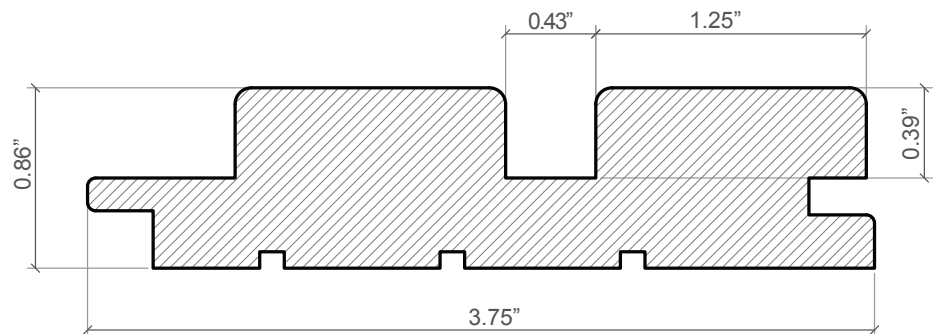

RIVA\CLADDING

Format: Wide slat

Species: Walnut

Color: Walnut



Product description

Add depth and personality to interior spaces with this decorative covering that will turn any room into a distinctive area. Usually found in living rooms or interior walls, its benefits include insulation and noise reduction. A work of art on its own!

Dimensions

Total thickness 7/8" (22mm)

Width 3 3/4" (96mm)

Length (ft) 10' (118")

Dimensional tolerances (EN 13647)

Length: Nominal $\pm 0.1\%$

Width: Nominal $\pm 0.2\%$

Cupping: 0.2% of nominal width

Banana: 0.1% nominal length

Construction

Solid

Finish

Water based varnish

Dimensional stability (EN-1910)

Movement $\leq 0.29\%$

Formaldehyde emission (EN-120)

E0. CARB2 comply

Noise & impact isolation (UNE-EN-ISO 140-8)

ΔL_w : 17 dB

Fire reaction (UNE 23727)

Cfl-S1

Profiling system

Tongue & groove, beveled 2 sides

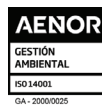
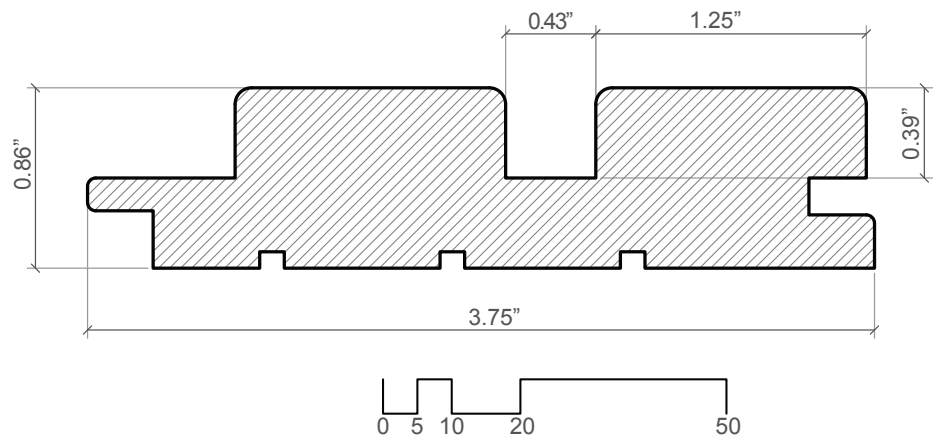

RIVA\CLADDING

Format: Regular slat

Species: White oak

Color: Crystal



Product description

Add depth and personality to interior spaces with this decorative covering that will turn any room into a distinctive area. Usually found in living rooms or interior walls, its benefits include insulation and noise reduction. A work of art on its own!

Dimensions

Total thickness 7/8" (22mm)

Width 3 3/4" (96mm)

Length (ft) 10' (118")

Dimensional tolerances (EN 13647)

Length: Nominal $\pm 0.1\%$

Width: Nominal $\pm 0.2\%$

Cupping: 0.2% of nominal width

Banana: 0.1% nominal length

Construction

Solid

Finish

Water based varnish

Dimensional stability (EN-1910)

Movement $\leq 0.29\%$

Formaldehyde emission (EN-120)

E0. CARB2 comply

Noise & impact isolation (UNE-EN-ISO 140-8)

ΔL_w : 17 dB

Fire reaction (UNE 23727)

Cfl-S1

Profiling system

Tongue & groove, beveled 2 sides

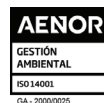
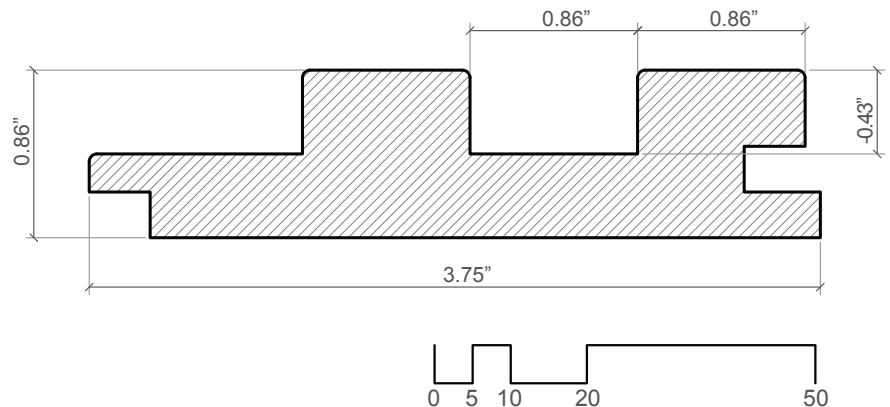

RIVA\CLADDING

Format: Regular slat

Species: White oak

Color: Pearl



Product description

Add depth and personality to interior spaces with this decorative covering that will turn any room into a distinctive area. Usually found in living rooms or interior walls, its benefits include insulation and noise reduction. A work of art on its own!

Dimensions

Total thickness 7/8" (22mm)

Width 3 3/4" (96mm)

Length (ft) 10' (118")

Dimensional tolerances (EN 13647)

Length: Nominal $\pm 0.1\%$

Width: Nominal $\pm 0.2\%$

Cupping: 0.2% of nominal width

Banana: 0.1% nominal length

Construction

Solid

Finish

Water based varnish

Dimensional stability (EN-1910)

Movement $\leq 0.29\%$

Formaldehyde emission (EN-120)

E0. CARB2 comply

Noise & impact isolation (UNE-EN-ISO 140-8)

ΔL_w : 17 dB

Fire reaction (UNE 23727)

Cfl-S1

Profiling system

Tongue & groove, beveled 2 sides

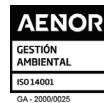
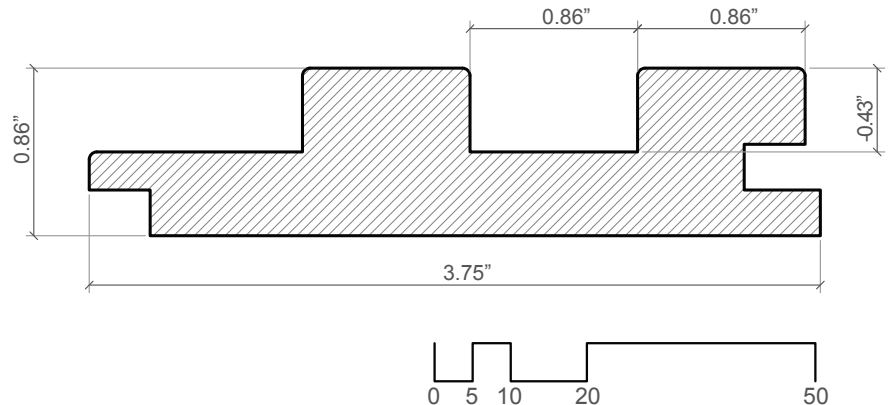

RIVA\CLADDING

Format: Regular slat

Species: Walnut

Color: Walnut



Product description

Add depth and personality to interior spaces with this decorative covering that will turn any room into a distinctive area. Usually found in living rooms or interior walls, its benefits include insulation and noise reduction. A work of art on its own!

Dimensions

Total thickness 7/8" (22mm)

Width 3 3/4" (96mm)

Length (ft) 10' (118")

Dimensional tolerances (EN 13647)

Length: Nominal $\pm 0.1\%$

Width: Nominal $\pm 0.2\%$

Cupping: 0.2% of nominal width

Banana: 0.1% nominal length

Construction

Solid

Finish

Water based varnish

Dimensional stability (EN-1910)

Movement $\leq 0.29\%$

Formaldehyde emission (EN-120)

E0. CARB2 comply

Noise & impact isolation (UNE-EN-ISO 140-8)

ΔL_w : 17 dB

Fire reaction (UNE 23727)

Cfl-S1

Profiling system

Tongue & groove, beveled 2 sides

